

Installation and Maintenance Instructions for All 2008 CU Compounds

General

The Pura Vida Air Systems 2008DT-FP is a stand alone unit used to reduce the levels of Volatile Organic Compounds (VOCs) and viable airborne biological contaminants. The unit is utilized as a ducted-in application for permanent installations. This unit will clean and recirculate the air in a room without disrupting the HVAC system. The 2008DT-FP uses one 1620 PCP panel in conjunction with up to two return filter grilles and supplies. It is suitable for spaces up to 8300 ft3. For recommended unit configurations, contact Pura Vida Air Systems. All Pura Vida Air Systems products incorporate 3-step PCO technology: MERV Filtration, UVGI Lamps and Photocatalysis.

Shipping and Packing List

- 1- Catalyst/Blower assembly
- 1- Drop Tile 4" Filter Grill
- 1- 20" x 20" 4" Merv 13 Filter

Note: Supply Grill and flex duct are supplied by installer.

Nomenclature

XXXX

2440 = 24" Height / 40" Length of catalyst

Packaged Unit Description

56 = Power Unit Compound (Line Voltage Input)

57 = Center Section Compound

58 = End Section Compound

WARNING



Electric shock hazard
Can cause injury of death Disconnect all remote electrical power supplies before servicing.
Access panels must be in place during operation.

WARNING



UVC light hazard. UVC light can cause temporary or permanent loss of vision and sunburn. Take proper precautions to protect eyes and skin from direct exposure.

WARNING!

Mercury Hazard. Do not Break
Each UVC lamp contains a small amount of Mercury. In case of breakage use proper disposal techniques on page 6-7.

WARNING!

Improper installation, adjustment, alteration, service or maintenance can cause property damage, personal injury or loss of life. Installation and service must be performed by a qualified installer or service agency.

Clearance and Requirements

Air Speed: 830 CFM

Pressure drop across catalyst: .05 in wc

UVGI life cycle: 12,000 operation hours

Installation location: Above ceiling tile grid.

Installation location preference: Return grill above odor source or sources. Separate supply grill at least 10 feet from return grill. System must recirculate space to achieve maximum efficiencies.

Clearance from AHU to nearest obstacle: Clearance must be at least the distance of the length longest compound installed in the system.

Safety Certifications

UL Classified UL File No. E326567

FIFRA....EPA EST No. 877447--TX--001

OSHPOD - Pending

UL REQUIREMENTS

- 105°C minimum supply connections
- For catalyst marked "XXXX", 50°C/122°F maximum ambient temperature. For those marked "XXXX-E", 80°C/176°F maximum ambient temperature.
- Suitable for air-handling units
- Access above ceiling may be required
- The health aspects associated with the use of this product and its ability to aid in disinfection of environment air have not been investigated by UL.
- Use only First Light type T5 lamps specified by the PCP Compound.
- **Warning:** *The electrical supply circuit connected to this UV appliance must be routed through an electrical interlock switch placed on the HVAC system duct access panels and doors to prevent accidental UV exposure when servicing the air ducts or equipment.*
- **Caution:** *Equipment Damage Hazard. Ultraviolet light can cause color shift or surface degradation and sometimes structural degradation of non-metallic components. Select mounting location that prevents exposure to plastic flexible duct components, polyurethane foam insulation material, rubber hoses, wiring insulation, filtration media, etc. If mounting options are limited, items above should be protected with ultraviolet resistant material such as aluminum foil, aluminum duct tape, or metallic shields.*

Dimensional Data



20" x 20" x 4" Filter Grill

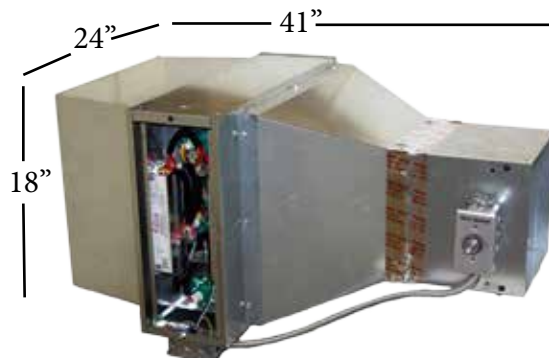



Weight 45lbs

2008 DT FP

Specifications

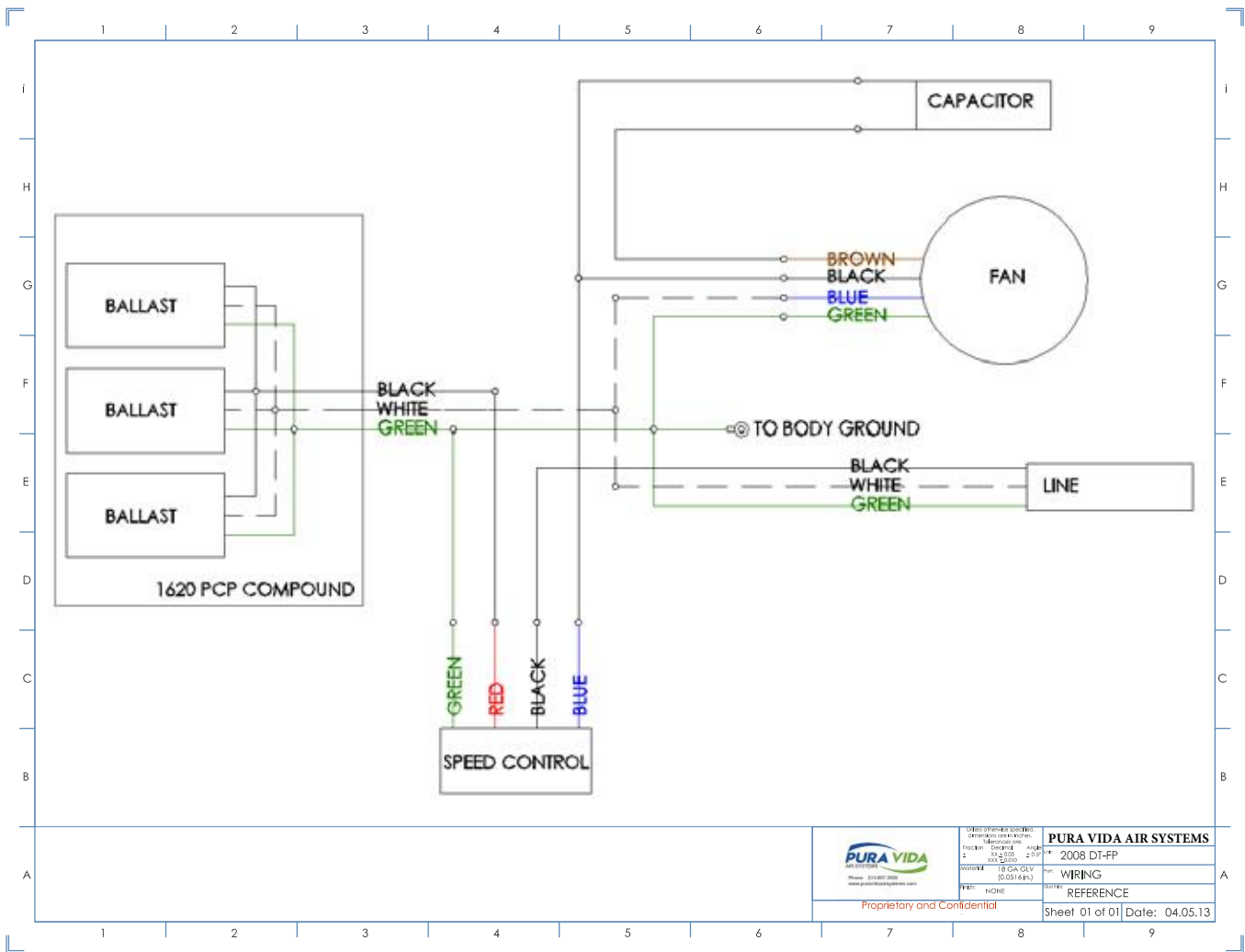
Voltage: 115 60 hertz
Amps: 4.7
CFM: 830



 Phone: 210-867-3500 www.puravidaairstystems.com	PURA VIDA AIR SYSTEMS 2008 DT-FP
	WIRING
	REFERENCE
	Sheet 01 of 01 Date: 04.05.13

Replacement part numbers and schedule

Lamps, catalyst and ballast should only be replaced by the Pura Vida Air Systems replacement parts.

Part	Description	Pura Vida Air Systems Part #
Ballast	Fulham WH-33	GA33
Catalyst	20"x 20"x 6"	GA2020E
Filter	20"x 20"x 4" MERV 13	GA2020413
Motor Assembly	Blower Motor Assembly	830FB
UVGI Lamps	First Light 2813	UVCHO20
UVGI Shielding	20"x 20"x 2"	GA2020UVS

Blower fan Curve

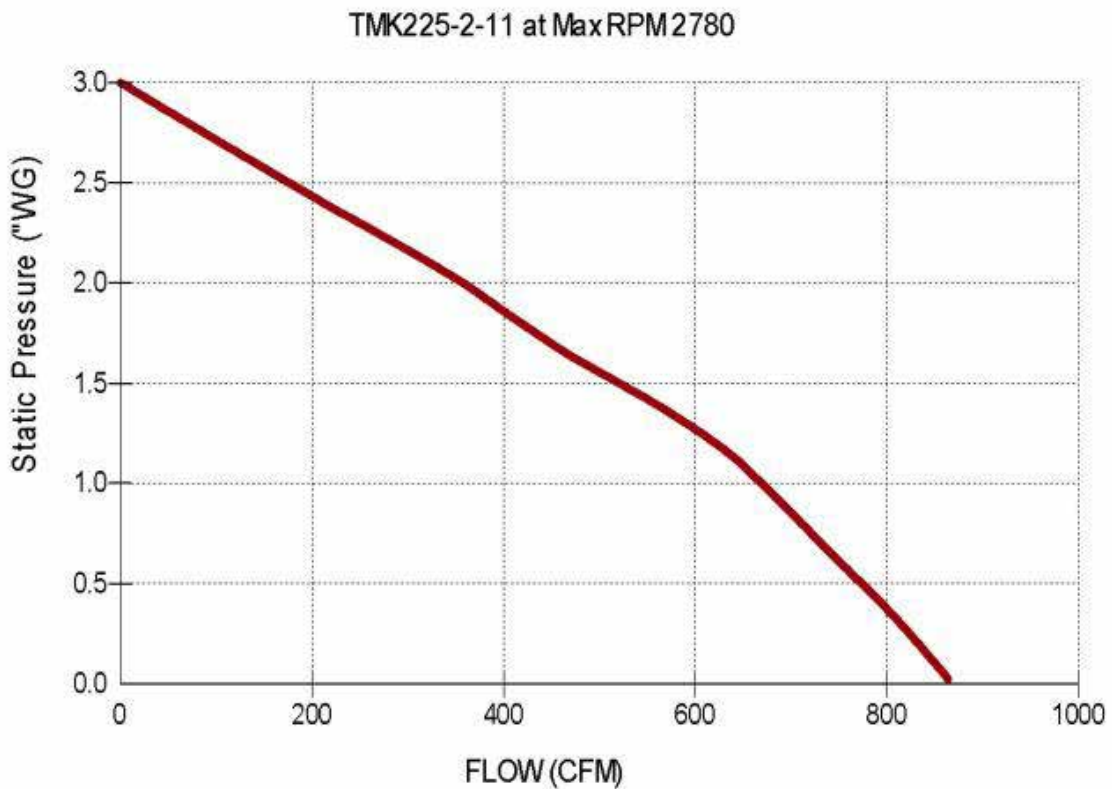

Pressure Drop Across Catalyst

PCP Standard 24"x24"x6" Pressure Drop

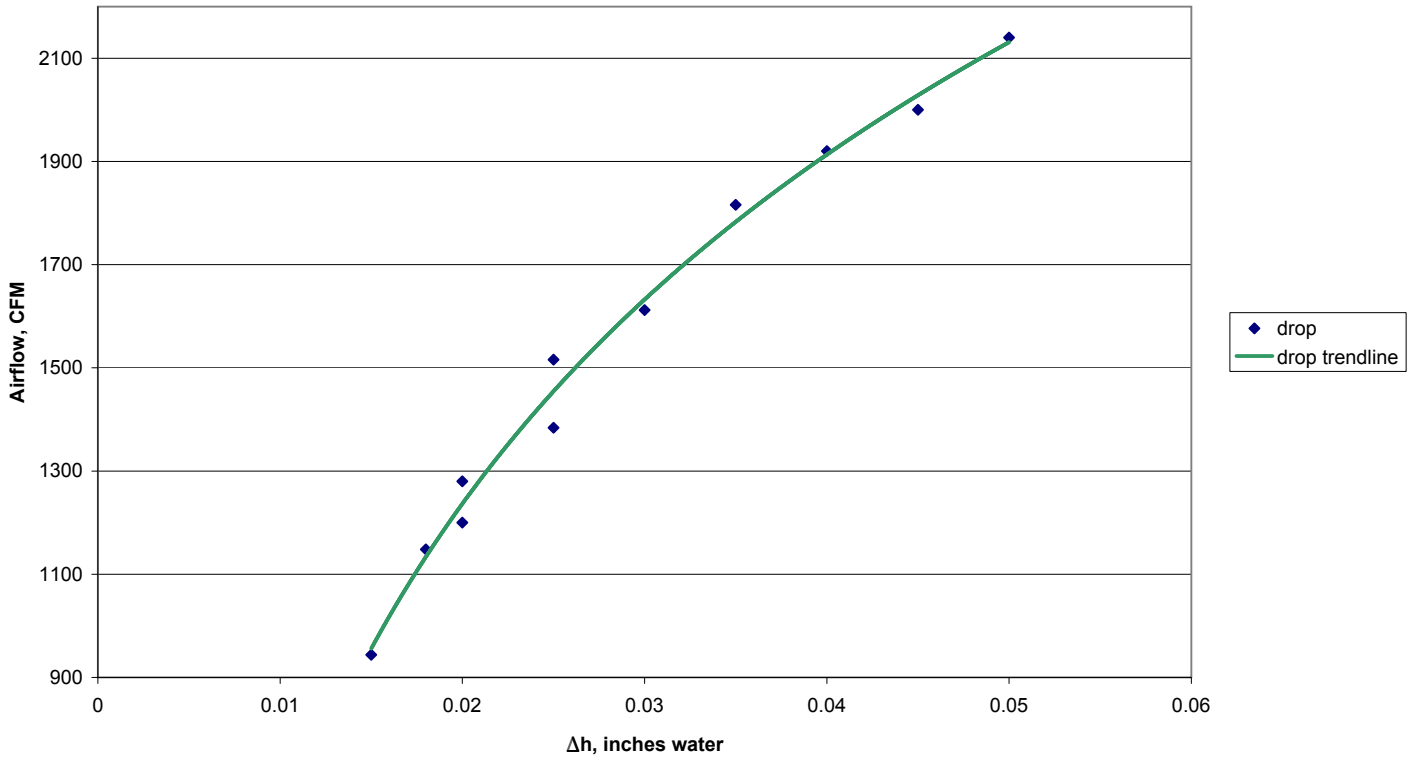

Air velocity, FPM	Air flow, CFM	Δh , in H ₂ O
236	944	0.015
287	1148	0.018
300	1200	0.02
320	1280	0.02
346	1384	0.025
379	1516	0.025
403	1612	0.03
454	1816	0.035
480	1920	0.04
500	2000	0.045
535	2140	0.05

Temp 74°F
 RH 38.4
 DEW 47.1
 Meter: Dwyer Magnehelic 1" scale
 ± 0.02"

Pura Vida Air Systems lamps do not produce ozone! The lamps provide a minimum intensity of 775 micro-watts/cm² (5 milliwatts per square inch) at 10.77 centimeters (4.24”) to activate the catalyst effectively. To maintain tested performance, lamps may not be substituted with another manufacturer’s products. These lamps provide UV-C wavelengths @ 254 nm. All lamps must be replaced every 16 months (12000 hrs) of continuous use to maintain intensity requirements. Pura Vida Air Systems lamps contain trace amounts of mercury, encapsulated within the lamp and therefore reducing risk to the consumer or ecosphere.

LAMP SERVICE

ALL UNITS MUST BE POWERED DOWN BEFORE REPLACING LAMPS.

ALL MAINTENANCE PERSONNEL MUST WEAR UV PROTECTIVE SAFETY GLASSES. ALL EXPOSED SKIN MUST BE PROTECTED BY UV RESISTANT CLOTHING.

GENERAL

To operate effectively, the lamps must be replaced every 16 months, as the intensity of the lamps decreases over time. The catalyst must be energized by the lamps to create the field of hydroxyl radicals that is required to remove VOCs and biologicals. Without the proper lamp output, VOCs and biologicals will not be reduced!

INSPECTION

- **To inspect the lamps, the lamps must be powered. Wear UV resistant face shields and personal protective equipment!**
- On all units, inspect the green mounting sleeves (Green Sleeve) on the unit. If the lamps are lit, they will emit a bright green glow.
- If any lamp is unlit, power off the unit. Unplug the wiring harness from the lamp and plug the harness onto a lamp known to be operational. Power on the unit. If the new lamp does not light, the problem could be in the ballast. Keep in mind that the safety switch will not allow the lamps to light if the filter grille door is open. **THIS IS NOT CONSIDERED POWERING DOWN THE UNIT!** A pressure-kill box is an accessory that provides electricians with single point to wire to and two safety devices. One will kill power to the lamps when pressure drops below a set point, and the other kills power to the lamps when an access door is opened. A momentary safety bypass, also included, will allow power to bypass the safeties to power the lamps for visual inspection.
- If the new lamp lights, the old lamp is faulty. Proceed to removal.

Removal

- **Power the Pura Vida Air Systems unit down using the kill switch or breaker to unit.**
- **Caution! The lamps may be hot! Wear gloves to protect hands.**
- Unplug the harness from the faulty lamp.
- Unscrew the Green Sleeve from the base of the unit and remove lamp with sleeve from the unit.

Disposal

- Mercury produces a hazardous waste. Every form of it is toxic and yet mercury is an essential element in millions of fluorescent lamps throughout the United States and millions more throughout the world. State and federal regulatory agencies are working to reduce mercury releases to the environment. Since January 1, 2000, the United States Environmental Protection Agency (USEPA) has allowed for spent lamps to be managed as Universal Wastes. The Universal Waste Rules (UWR) are designed in part to simplify the management of mercury-containing wastes including spent fluorescent lamps. The Rules are also intended to encourage recycling, thereby reducing mercury emissions to the environment.

As an alternative to managing lamps as universal wastes, a facility may elect to manage its spent lamps as hazardous wastes. Hazardous waste rules - like the universal waste rules - are promulgated under the federal Resource Conservation Recovery Act (RCRA) and state laws equivalent to RCRA. RCRA regulates hazardous wastes "from the cradle to the grave." RCRA Subtitle C requires a waste generator to properly identify, treat, store, transport and dispose of hazardous wastes. The USEPA oversees the RCRA program but has delegated to the States the responsibility for the day-to-day management of the program.

List of Lamp Recycling Facilities for the US

AERC Recycling Solutions - Hayward, CA	Universal Recycling Technologies -Janesville, WI
AERC Recycling Solutions - West Melbourne, FL	Veolia ES - Phoenix, AZ
AERC Recycling Solutions - Allentown, PA	Veolia ES - Tallahassee, FL
Universal Recycling Technologies - Dover, NH	Veolia ES - S toughton, MA
Universal Recycling Technologies - Clackamas, OR	Veolia ES - Port Washington, WI
Universal Recycling Technologies - Fort Worth, TX	

Installation

- Installation is the reverse of removal
- Push socket onto lamp pins until socket butts against lamp



Catalyst

- ALL UNITS MUST BE POWERED DOWN BEFORE SERVICING.
- ALL MAINTENANCE PERSONNEL MUST WEAR UV PROTECTIVE FACE SHIELDS. ALL EXPOSED SKIN MUST BE PROTECTED BY UV RESISTANT CLOTHING.

General

Pura Vida Air Systems recommends catalyst replacement every fifteen years to provide an efficient system. As debris and contaminants accumulate on the catalyst, the effectiveness of the catalyst is decreased. The catalyst must be inspected periodically for buildup of particulate.

Inspection

- Power down the unit undergoing inspection.
- Locate the Pura Vida Air Systems PCP Compound in question.
- Visually inspect each catalyst wearing UV protective clothing and face shields. If the catalyst appears clean and free of particulate, proceed to the next unit. If the catalyst cannot be seen, continue to next item.
- Remove some of the lamps. With a flashlight, visually inspect the catalyst through the holes.
- If the catalyst appears clean and free of particulate, replace lamps and proceed to the next AHU. Otherwise, proceed to removal.

Cleaning

- If the catalyst needs cleaning from light to moderate dust build up. Disconnect power, use a hand sprayer with water only and rinse the catalyst. Avoid heavy concentrations of spray on ballast tray.
- If catalyst is soiled by resin (E.T.S.) or grease. Remove and spray catalyst liberally with Nu-Calgon CalClean, Special HD or other suitable coil cleaner on catalyst only. Allow to sit 15 minutes, then wash off with pump up water spray bottle. Do not remove installation reminders!
- Allow catalyst to lightly dry before returning to service.

Removal

- If catalyst will be cleaned and reused, keep track of which area the catalyst came from so they will be returned from where they were removed. This will prevent installation problems. Write or draw on the metal frames to help with installation.
- Remove all lamps from the catalyst.
- Remove from the rack. *You may need to contact the installer.*

WARNING!

**High pressure spray will damage the windowing
in the catalyst substrate**

Power

Ballasts are matched to the specific length of lamp. To maintain tested performance, ballasts may not be substituted with another manufacturer's products. The ballasts must be specified either 120v or 240v, 60 Hz: contact the factory for other voltage/frequency requirements. The ballast operating temperature range is -20°F to 158°F.

Safety

UVGI

Ultraviolet germicidal irradiation (UVGI) used for the activation of the PCO Catalyst. The residual light can be used for irradiating the evap. coil surface for biological microorganisms but presents a variety of potential health hazards to humans as well, including eye damage, skin burns, and even has the potential to cause skin cancer. Because germicidal UV rays are invisible to the eye, humans may be subject to hazardous doses of UV long before they realize it. There is no Occupational Safety and Health Administration (OSHA) standard for exposure to ultraviolet light. UV can be associated with adverse health effects depending on duration of exposure and the wavelength. The adverse health effects that may occur are erythema (sunburn), photokeratitis (a feeling of sand in the eyes), skin cancer, melanoma, cataracts, and retinal burns. Since maintenance personnel may be accidentally exposed to the radiation from UV lamps while in the course of their duties, it is essential that all UV sources and facilities be adequately labeled to instruct such personnel of the danger of exposure (in some cases, these warnings should be in both English and Spanish; Danger – Ultraviolet Radiation > Peligro -- Radiación Ultravioleta). Ideally, all activated UV sources should either be attended by knowledgeable personnel at all times.

- DISCONNECT ALL POWER TO SYSTEM BEFORE SERVICING
- PROPER **SAFETY GLASSES** OR FACE SHIELD MUST BE WORN WHEN INSPECTING OPERATIONAL LAMPS
- PROPER CLOTHING MUST BE WORN TO COVER EXPOSED SKIN
- **ALL ENTRY DOORS THAT HAVE DIRECT SITE TO THE CATALYST MUST HAVE SAFETY LIMIT SWITCHES INSTALLED TO SHUT OFF LAMPS DURING ENTRY INTO AHU.**
- ALL VIEWING WINDOWS OR PORTS MUST BE HAVE UV RESISTANT AND FILTERING PROPERTIES. **NO GLASS IS PERMITTED**
- Harden all plastic in direct site of the catalyst (Foil Tape)
- All field wiring when possible should be in metal conduit or of a UV resistant type.
- In case of lamp breakage the lamps are incased in a Teflon coating to reduce any chance of glass or mercury of entering the air stream.

Installation

WARNING!

Do not use silicone to seal catalyst racks to floor or ceiling. The presence of silicone in UV light will pollute the catalyst.

WARNING!

Sharp edges hazard.
Equipment sharp edges can cause injuries
Use protective gloves when grasping equipment edges.

WARNING!

Unpacking required

Remove all protective packing material from the box before removal of catalyst panel. All packing material should be discarded properly.

WARNING!

Lamps contain Mercury.

Ingestion or contact with mercury or mercury vapor is hazardous to your health.
Take care when handling lamps. If broken, avoid contact with mercury

This unit is designed to be installed in the drop-tile ceiling grid. Installation must be completed by competent personnel. Pura Vida Air Systems assumes no liability for damages or injuries sustained for installations done by other than qualified technicians. The DT FP series is designed as a recirculation system for airborne contaminants. The 2008 DT FP is not a single pass removal system.

- Choose a return close to the source of odors or biologicals. The lamp/filter section should be installed in this general vicinity. Also, choose a location for the supply. As a rule of thumb, the supply and return should be no greater than 20' apart.
- Using a lift, ladder or scaffolding, remove a ceiling tile above the source. Use judgment here: there needs to be clearance from permanent ductwork, beams, lights, sprinklers or other above-ceiling fixtures. If an adjacent tilespace is better, remove the tile and make sure. You must have clearance to remove 20" lamps from the PCP.
- Using a helper, lift the lamp/filter section up above the ceiling grid. The unit may need to be angled thru the gridwork. Gridwork may need to be removed to provide adequate room. Once the unit is above the grid, set the unit onto the grid carefully. You should see the 4" particulate filter from the ground. The ballast box may be attached to this section, attached to adjacent wall or suspended from the roof.
- Use the same guidelines to add more returns and/or supplies.
- Remove a ceiling tile in between the return(s) and supply(s). The fan unit must be suspended from the roof truss or beams using Unistrut, all-thread or chain. The airflow must point toward the supply(s). Install fan at least 7' above floor.
- Using a 4-conductor cable (not included) or other means, connect the safety switch to line in power, then to black from speed control. Connect black from ballast to auxiliary (red) of speed control. White from speed control connects to neutral. Follow all applicable codes and guidelines; refer to authority having jurisdiction.
- Attach ductwork. Note: If ductwork is altered, installer must insure that no leakage of UV light occurs as a result of ductwork modifications!
- Air must flow from the return to the fan, then to the supply.

Ballast Troubleshooting Chart

Figure 1a



TROUBLESHOOTING ALL FLUORESCENT FIXTURES

SAFETY FIRST: Voltage and current measurements present possibility of exposure to hazardous voltages and should be performed only by qualified personnel. Many troubleshooting techniques require measurement with input voltage applied requiring extra precautions to avoid electrical shock. Use proper safety equipment such as eye protection and gloves when performing electrical measurements.

INOPERATIVE FIXTURE

Often a fixture becomes inoperative due to causes not attributable to the ballast. It is therefore important to examine all fixture components before removing the ballast for replacement. We recommend the following general procedures for both magnetic and electronic ballast:

1. Replace or check all lamps to ensure satisfactory operation.
2. As lamps are removed, examine all sockets to ensure they are not damaged or broken and are making proper and positive contact with the lamps.
3. Examine all electrical connections within the fixture, including at the lamp sockets, to ensure conformance with the wiring diagram on the ballast.

Figure 1a is a systematic approach for troubleshooting most problems that arise regarding fixtures using ballasts with startup protection. For those situations when these documents do not assist in correcting the problem, the manufacturer should be contacted to coordinate with the lamp and ballast manufacturers for further actions.

NOTE: Programmed Start Ballasts include lamp end-of-life circuitry. This circuit is included to maximize lamp life when one lamp fails in the circuit. The feature enables the ballast to detect when lamps fail and safely remove power from the lamps by going into a shutdown mode. The ballast also goes into a shutdown mode when it detects lamps not properly placed in the sockets. When troubleshooting the circuit, make sure to replace inoperative lamps or make sure lamps are placed properly in the sockets. Programmed Start ballasts also include a re-strike feature that will restart the lamps after the failed lamp has been replaced. Open circuit voltage cannot be measured due to lamp end-of-life circuitry.

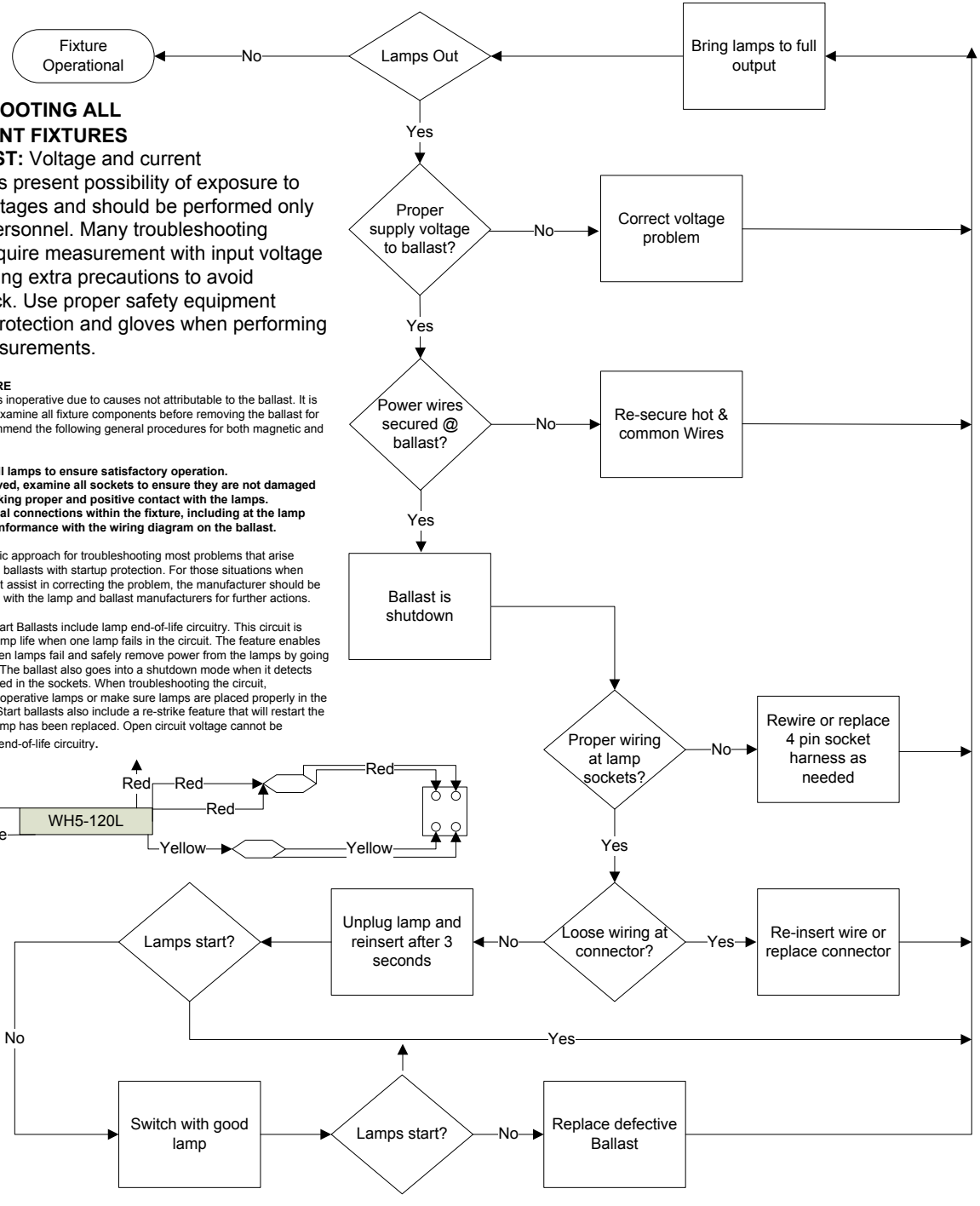
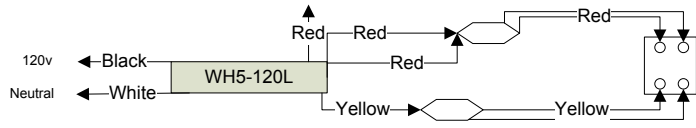

General Pura Vida Air Systems Spec Sheet

The following is a guide specification for the Pura Vida Air Systems PCP (Populated Catalyst Panel) Compound Product. This specification is not intended to be used without editing, as there are numerous choices throughout the document (enclosed in brackets “[]” & **highlighted in blue**) that require decisions to be made by the specifying design professional. **PURA VIDA AIR SYSTEMS IS NOT RESPONSIBLE FOR THE USE OF SUPERCEDED OR INACCURATE SPECIFICATIONS BY OTHERS.** *Designers are encouraged to check with their local Manufacturer’s Representative, or with Pura Vida Air Systems, to ensure that the guidance documents being used are the latest revision.*

1.0 PHOTOCATALYTIC OXIDATION (PCO) UNIT

PCO unit shall be factory-fabricated and tested two-part integral assembly for treatment of air by: (1) Ultraviolet Germicidal Irradiation (UVGI) using UVC lamps; and (2) Photocatalytic Oxidation using TiO₂ media. Assembly shall be housed in casing. The combination of UVC lamps and TiO₂ media is intended to create hydroxyl radicals at the surface of the media (Passive) and not to broadcast radicals into the occupied spaces (Active).

1.1 Unit Casing

Casing shall be of single-wall construction, fabricated of [5052 aluminum] [24 gauge 304 stainless steel] [22 gauge galvanized steel]. All portions of the casing shall be free from sharp edges and burrs. Casing shall be 5 13/16” deep.

1.2 Unit Capacity

Unit shall be rated for a maximum velocity across the unit face of 500 feet per minute.

1.3 UL Certification

The entire PCP assembly shall bear the UL Classification Mark and be investigated in accordance with ANSI/UL 1598, “Luminaires,” and ANSI/UL 1995, “Heating and Cooling Equipment,” under the Air Duct Mounted Acces-sories category (ABQK). Compliance is to be verified by the UL Online Certifications Directory.

1.4 PCO Media

Media shall consist of six-inch (nominal) non-metallic media with face area to match casing opening, pleated at one pleat per inch (nominal), with a 40-200 nanometer TiO₂ coating. PCO media shall be placed perpendicular to the air stream in the unit casing. Media shall have an internal mechanism to eliminate the silica produced by the oxidation of ethanol.

1.5 UVGI Lamps & Ballasts

Lamps and ballasts shall be designed specifically to provide type-C ultraviolet light with a wavelength at or near 2537 Angstroms. Lamps shall be non-ozone-producing. Lamps shall be Teflon-coated to reduce breakage. Sufficient lamps shall be provided and positioned center point through the media equidistant from edges so as to achieve a minimum coverage of 9.5 milliwatts per square inch of UVC light, upstream and downstream, across all exposed surfaces of the PCO media. Lamp UVC output shall not drop below 9.5 milliwatts per square inch over their usable 12000 hr life.

1.6 Electrical

Unit shall be configured to operate with 120V/1 ϕ /60Hz electrical power. Unit shall be provided with junction box for point of connection.

1.7 Racking System

The racking system shall be constructed as either a front-loading or side-loading design. Either system must show proof of conformance to ICB 2012, CBC 2010 and ICC AC-156 (2010). The catalyst and the racking system shall bear the OSP certification number.

1.8 Unit exemplified by:

Manufacturer: Pura Vida Air Systems
Model No.: [XXXX] [E] PCP Compound
Manufacturer's Website: www.puravidairsystems.com



Phone 210-867-3500
www.puravidairsystems.com

LIMITED WARRANTY

FAILURE TO MAINTAIN YOUR EQUIPMENT WILL VOID THIS WARRANTY

Your PURA VIDA AIR SYSTEMS purification system is expressly warranted from the date of installation to be free from manufacturing defects for the coverage period stated below. Defective parts must be returned no later than thirty (30) days after the failure by you to the installing contractor together with the PURA VIDA AIR SYSTEMS purification system’s model number, serial number, and documented installation date of the PURA VIDA AIR SYSTEMS purification system.

ONE (1) YEAR COVERAGE -- RESIDENTIAL AND COMMERCIAL APPLICATIONS

The covered equipment and covered components are warranted by PURA VIDA AIR SYSTEMS for a period of ONE (1) year from the date of the original unit installation, when installed in a residential or commercial application. If during this period, a covered component fails because of a manufacturing defect, PURA VIDA AIR SYSTEMS will provide a free replacement part. You must pay shipping charges and all other costs of warranty service. PURA VIDA AIR SYSTEMS will not pay labor involved in diagnostic calls or in removing, repairing, servicing or replacing parts. Such costs may be covered by a separate warranty provided by the installer.

NOTE - If the date of original installation cannot be verified, the warranty period will be deemed to begin six (6) months after the date of manufacture.

EXCLUDED COMPONENTS

The following components are not covered by this warranty: the UVCGI lamps or the pleated photo catalytic material. These are replacement items, which must be replaced as stated in the Maintenance section of the installation instructions to ensure effective operation.

REPAIRS

All repairs of covered components must be made with authorized service parts by a qualified service dealer or contractor. Labor charges are not covered by this warranty.

WARRANTY LIMITATIONS

This warranty will be voided if the covered equipment is removed from the original installation site. This warranty does not cover damage or defect resulting from:

- 1 - Flood, wind, fire, lightning, or installation and operation in a corrosive atmosphere (chlorine, fluorine, salt, recycled waste water, urine, fertilizers, or other damaging chemicals).
- 2 - Accident, or neglect or unreasonable use or operation of the equipment, including operation of electrical equipment at voltages other than the range specified on the unit nameplate (includes damages caused by brownouts).
- 3 - Modification, change or alteration of the equipment, except as directed by PURA VIDA AIR SYSTEMS.
- 4 - Operation with system components (indoor unit and control devices), which do not match, or meet the specifications recommended by PURA VIDA AIR SYSTEMS.
- 5- Operation with system components (indoor unit and control devices), which exceed operational temperature range of -20 F to 122F.

THIS WARRANTY SHALL NOT OBLIGATE THE MANUFACTURER FOR ANY LABOR COSTS AND SHALL NOT APPLY TO DEFECTS IN WORKMANSHIP OR MATERIALS FURNISHED BY THE INSTALLING CONTRACTOR AS CONTRASTED TO DEFECTS IN THE PURA VIDA AIR SYSTEMS PURIFICATION SYSTEM ITSELF. IMPLIED WARRANTIES OF MERCHANTABILITY OR FITNESS FOR A PARTICULAR PURPOSE SHALL BE LIMITED IN DURATION TO THE AFORESAID COVERAGE PERIOD. THE MANUFACTURER’S LIABILITY FOR INCIDENTAL OR CONSEQUENTIAL DAMAGES, OTHER THAN DAMAGES FOR PERSONAL INJURIES, RESULTING FROM ANY BREACH OF THE AFORESAID IMPLIED WARRANTIES OR THE ABOVE LIMITED WARRANTY IS EXPRESSLY EXCLUDED. THIS LIMITED WARRANTY IS VOID IF DEFECT(S) RESULT FROM FAILURE TO HAVE THIS UNIT INSTALLED BY A QUALIFIED HEATING AND AIR CONDITIONING CONTRACTOR. IF THE LIMITED WARRANTY IS VOID DUE TO FAILURE TO USE A QUALIFIED CONTRACTOR, ALL DISCLAIMERS OF IMPLIED WARRANTIES SHALL BE EFFECTIVE UPON INSTALLATION.

Some states do not allow limitations on how long an implied warranty lasts or the exclusion or limitation of incidental or consequential damages, so the above exclusion or limitations may not apply to you. This warranty gives you specific legal rights and you may also have other rights, which vary from state to state.

To register your new PURA VIDA AIR SYSTEMS Purification System, PLEASE CUT ON DOTTED LINE AND RETURN THE REGISTRATION FORM TO THE ADDRESS NOTED BELOW.

Customer Registration Form

Customer Name: _____
 Address: _____
 City: State/Province: Zip/Postal Code: _____
 Home Phone: E-mail: _____
 Installing Contractor: Phone: _____
 Date of installation: Model Number: _____ Serial Number: _____

Please send this completed form to:
PURA VIDA AIR SYSTEMS
 207 Devine St.
 San Antonio, TX 78210